

Data Sheet



Article number: 203260M1675A1U

Description: E+G levelling foot

GN 32-60-M16-75-A1-U

Note: U Without nut, Hexagon socket at the top, Wrench flat at the bottom

Measures

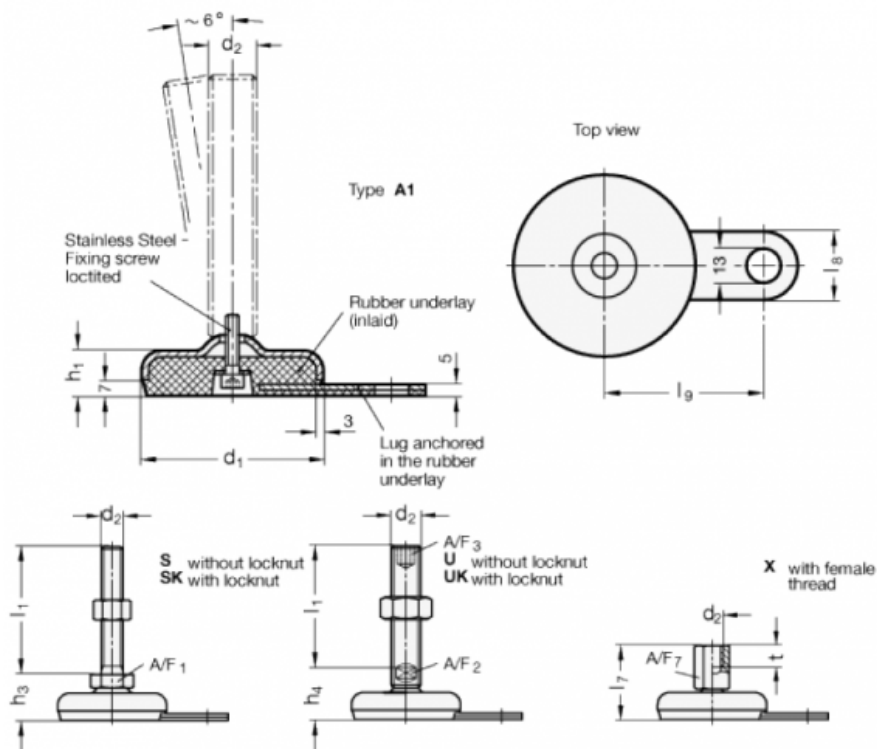

A/F2 = 12

l9 = 50

A/F3 = 8

d1 = 60

d2 = M16

h1 = 19

h4 = 33

l1 = 75

l8 = 25